

CUM VIVERE

CV - TAVOLO

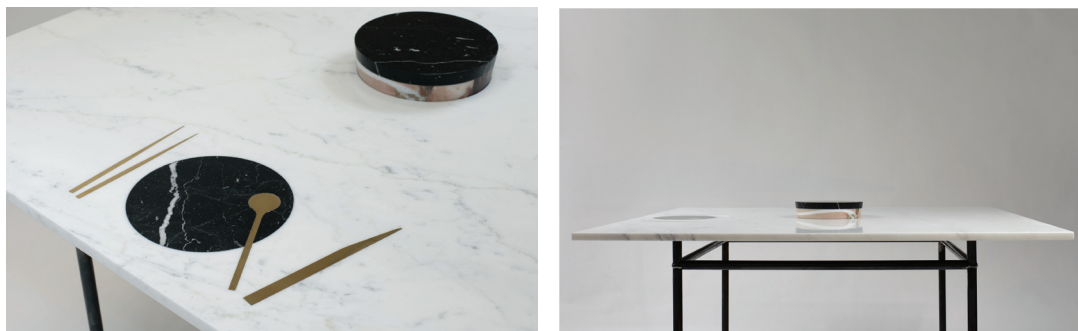

CV 01

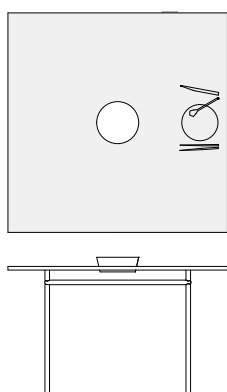

CV 01A

dimensioni
120x120

CV 01B

dimensioni
140x140

dimensioni vaso
d 21-19
h 8

CV 02

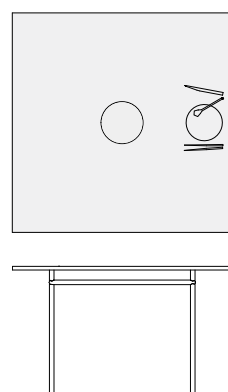

CV 02A

dimensioni
120x120

CV 02B

dimensioni
140x140

CV 03

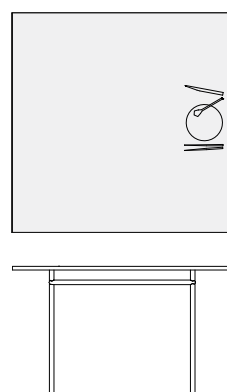

CV 03A

dimensioni
120x120

CV 03B

dimensioni
140x140

CV 04

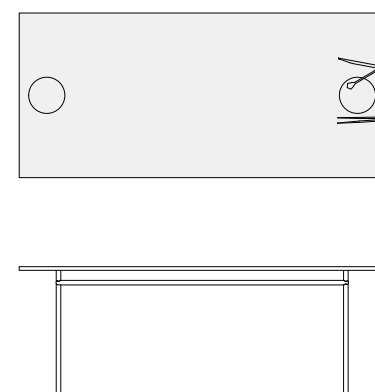

CV 04A

dimensioni
90x240

CV 04B

dimensioni
60x200

CUM VIVERE

CV - TAVOLO

Materiali | componenti personalizzabili.

01

PIANO



**marmo
michelangelo**

INTARSIO

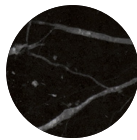

**marmo nero
marquina**

INTARSIO

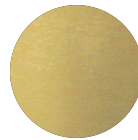

ottone

TELAIO

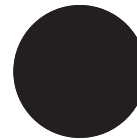

**metallo
verniciato**

02

PIANO



**marmo bianco
Carrara**

INTARSIO



**marmo rosso
verona**

INTARSIO

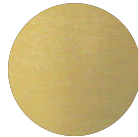

ottone

TELAIO



**metallo
verniciato**

Finitura | levigata, lucidata, satinata (a seconda dei materiali). Olio alimentare per legno.

Manutenzione del prodotto | pulire con un panno morbido umido, se necessario usare sapone di marsilia 100% naturale diluito in acqua, asciugare accuratamente. Non lavare in lavastoviglie e non mettere in congelatore.

Il marmo e il legno sono materiali naturali lavorati artigianalmente, sono caratterizzati da nodi e venature che rendono ogni pezzo leggermente differente dall'altro.



bettisatti.srl
P.I. 02507670467
via Tagliate di S. Marco 124,
55100 Lucca (LU)
www.bettisatti.it
info@bettisatti

CUM VIVERE

CV - TABLE

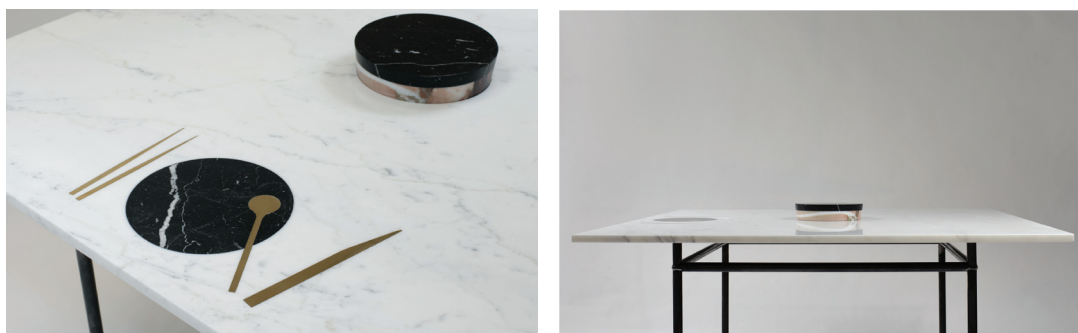

CV 01

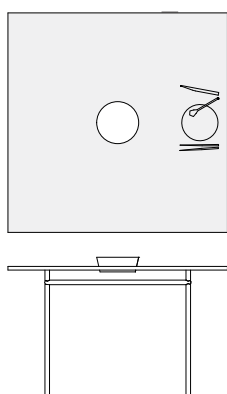

CV 01A

dimensions
120x120

CV 01B

dimensions
140x140

vase dimensions
d 21-19
h 8

CV 02

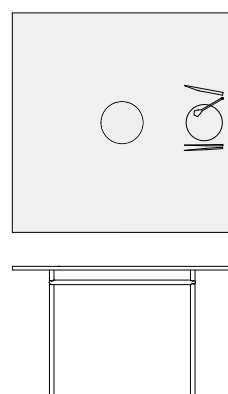

CV 02A

dimensions
120x120

CV 02B

dimensions
140x140

CV 03

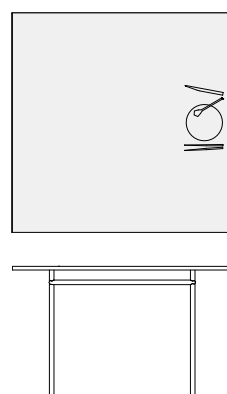

CV 03A

dimensions
120x120

CV 03B

dimensions
140x140

CV 04

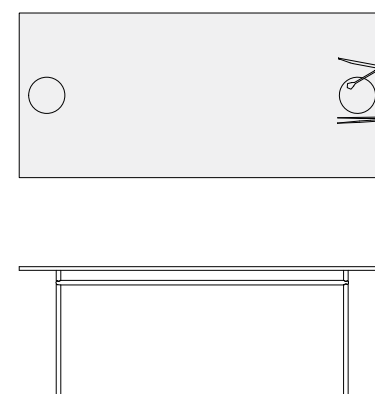

CV 04A

dimensions
90x240

CV 04B

dimensions
60x200

CUM VIVERE

CV - TABLE

Materials | customizable components.

01

TABLE TOP



michelangelo
marble

INLAY

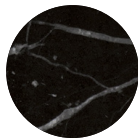

marmo nero
marquina

INLAY

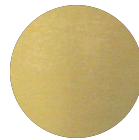

ottone

FRAME



metallo
verniciato

02

TABLE TOP



marmo bianco
Carrara

INLAY



marmo rosso
verona

INLAY

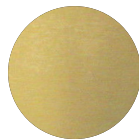

ottone

FRAME

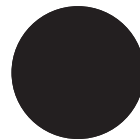

metallo
verniciato

Finish | sanded, polished, satin finish (depending on materials). Edible oil for wood.

Product maintenance | clean with a soft damp cloth, if necessary use 100% natural marsilia soap diluted in water, dry thoroughly. Do not wash in dishwasher and do not put in freezer.

Marble and wood are handcrafted natural materials and are characterized by knots and grains that make each piece slightly different from the other.



bettisatti.srl
P.I. 02507670467
via Tagliate di S. Marco 124,
55100 Lucca (LU)
www.bettisatti.it
info@bettisatti